

# Title: Crius AIO V1.0 & V1.1 & MegaPirateNG

**Document Name:** CriusMegaGuideV1.1

**Version:** V1.1

**Date:** 22<sup>nd</sup> Oct 2012

**Author:** Jumpy07

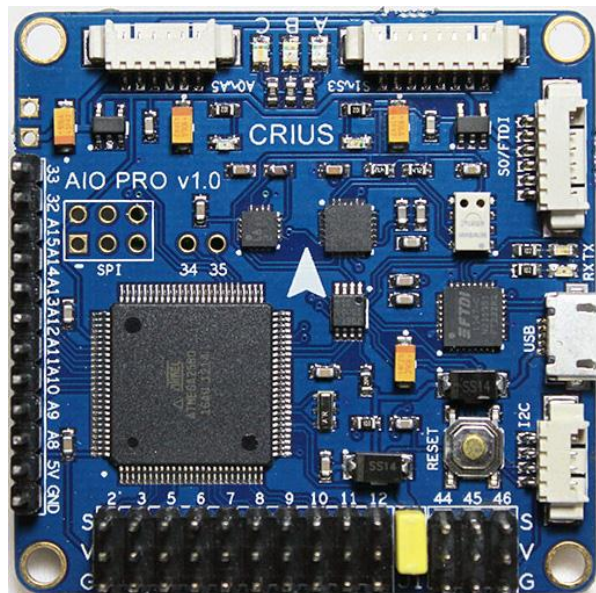

**Please Read:** This is guide is written to assist new users of the Crius AIO getting started and is specifically written for those using MegaPirateNG software.

The guide uses various sources and where relevant these have been highlighted, credits and reference given.

This is a working document written by someone new to the hobby and as such may have omissions and errors, so you use at your own risk.

Most of this information is available is various places on the web, but have tried to bring this into one document that is more relevant to the Crius AIO Pro V1.0/V1.1 and MegaPirateNG

If you are installing MultiWii on your Cruis AIO Pro then check out this excellent guide from Gaza07  
: <http://www.multi-rotor.co.uk/index.php?action=dlattach;topic=411.0;attach=940>

## Contents

Hardware .....	3
Connections .....	4
Board Layout.....	6
Installing MegaPirateNG .....	7
Status LED's.....	15
APM Planner .....	16
Power considerations .....	17
Extend Board + GPS .....	18
GPS Connections.....	20
Sonar .....	21
CPMM – PPM SUM .....	22
Bluetooth.....	23
3DR Radio's.....	24
MinimOSD.....	28
JD-IO Board – FrSky Telemetry .....	29
Buzzer .....	32
AttoPilot .....	32
First Tests (Written for a Quad but similar principles apply to most Multi's) .....	34
Tuning PIDS.....	34

## Hardware

### Features:

- Up to 8-axis motor outputs
- 8 input channels for standard receiver / support for PPM Sum / CPPM
- 4 serial ports for debug/Bluetooth Module/OSD/GPS/telemetry
- 2 servos output for PITCH and ROLL gimbal system
- A servos output to trigger a camera button
- 6 Analog output for extend device
- A I2C port for extend sensors or devices
- Separate 3.3V and 5V LDO voltage regulator
- ATmega 2560 Microcontroller
- MPU6050 6 axis gyro/accel with Motion Processing Unit
- HMC5883L 3-axis digital magnetometer
- MS5611-01BA01 high precision altimeter
- FT232RQ USB-UART chip and Micro USB receptacle
- On board logic level converter

### Flight modes for MegaPirateNG

- Acro
- Alt Hold
- Simple
- Loiter (uses GPS)
- Guided (uses GPS)
- Position (uses GPS)
- Circle (uses GPS)
- RTL (uses GPS)
- Auto (uses GPS)
- Follow Me (uses GPS)

### Other

- Dimension: 50mmX50mm
- Height: 11.6mm
- Weight: 14.2g
- Fixing hole spacing: 45mm
- Hole diameter: 3mm

### Package contents

- AIO PRO FC x 1
- 3Pin to 1Pinx3 cable 100mm x 3
- 3Pin to 3Pin cable 100mm x 1
- Molex 1.25mm 4Pin cable 100mm x1
- Molex 1.25mm 6Pin cable 100mm x1
- Molex 1.25mm 8Pin cable 100mm x2

## Connections

- **Extend Power:** if you don't power it by the BEC from the ESC. This is also needed to power the Expansion Board.
  
- **Receiver Connections**
  - GND – To Receiver Ground
  - 5v – To power Receiver 5V
  
  - A8 / THROTTLE – To Receiver (also used for PPMSUM / CPPM Input)
  - A9 / ROLL – To Receiver
  - A10 / PITCH – To Receiver
  - A11 / YAW – To Receiver
  - A12 / AUX1 – Normally channel 6 Receiver
  - A13 / AUX2 – Normally channel 7 Receiver
  - A14 / AUX3
  - A15 / AUX4
  
  - CAM PITCH - Input from Receiver
  - CAM ROLL - Input from Receiver / (Pin 32 also used for optional Buzzer)
  
- **Motor Connections**
  - 2 – Motor Connection
  - 3 – Motor Connection
  - 4 – Motor Connection
  - 5 – Motor Connection
  - 6 – Motor Connection
  - 7 – Motor Connection
  - 8 – Motor Connection
  - 9 – Echo for Ultrasonic
  - 10 – Trigger for Ultrasonic
  - 11 – Motor Connection
  - 12 – Motor Connection
  
- **Motor connection - D2/D3/D5/D6/D7/D8/D11/D12 (See Appendix for Motor Layouts)**
  - 46 / TRIGGER (Camera Gimbal Servo)
  - 45 / ROLL (Camera Gimbal Servo)
  - 44 / PITCH (Camera Gimbal Servo)

**I2C port** (Scl, Sda, 5v, Gnd) - For I2C Sensors and I2C GPS (Optional)

**S0/FTDI (known as console in MegaPirateNG Code**

- (Gnd, gnd, 5v, rx0, Tx0, Dtr) - can be connected a Bluetooth module
- (This is shared with USB port and cannot be used at the same time)

**S1-S3**

- (Tx1, Rx1, Tx2, Rx2 Tx3, Rx3, Vcc, Gnd)
- RX1/TX1 used for Remzibi's OSD board (Not tested), (FrySky Telemetry interface coming in future)  
TX2/RX2 used for GPS, you can connect any standard NMEA GPS receiver
- TX3/RX3 used for telemetry modules ,like Xbee, 3DRadio or MinimOSD

**A0-A5**

- - A0 and A1 used for Attopilot

Board Layout

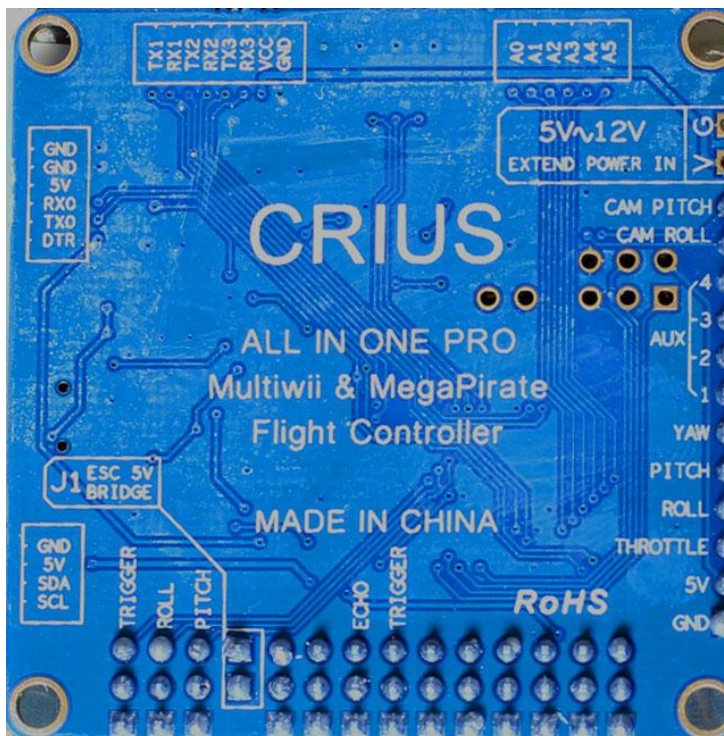
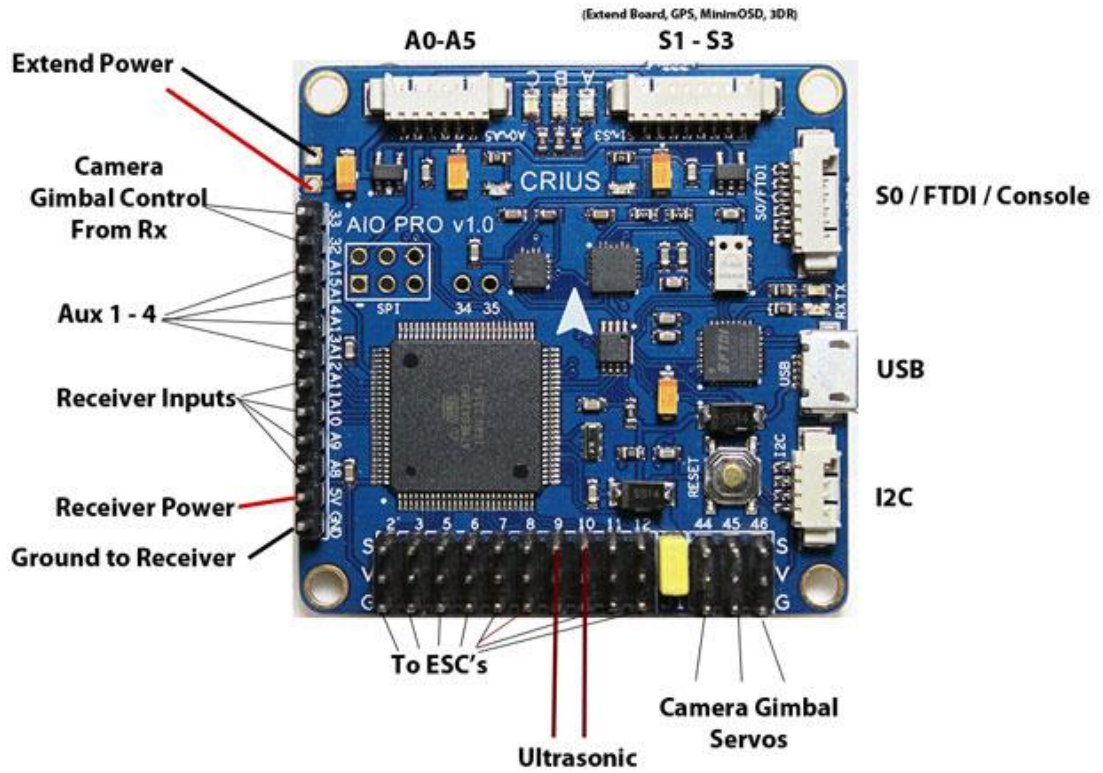

## Installing MegaPirateNG

MegaPirateNG is a port of Arducopter for the Crius AIO and other supported boards. Not all features work on the Crius as Arducopter was written for the APM boards originally.

To install MegaPirateNG on your Crius AIO we first of all need to download two programs and their associated files and libraries.

1. MegaPirateNG - Latest MegaPirate can be found here <http://code.google.com/p/megapirateng/downloads/list>
2. Arduino - Arduino can be found here <http://arduino.cc/en/Main/Software>

Now we can get started...

- Arduino is used to configure and compile the MegaPirateNG Code and upload it to your Crius AIO.
- Create a directory on your PC called Crius (on your desktop will be fine)
- Inside the Crius directory create two more directories, Arduino and MegaPirate.
- Unzip the MegaPirateNG files into the MegaPirate Directory you created
- Unzip the Arduino files into the Arduino Directory you created.
- Now open the MegaPirate Folder and copy the Libraries folder to the Arduino Folder (you will be prompted and asked if you wanted to merge the two directories and overwrite any files etc).
- Now open up the Arduino folder and run Arduino. The screen will look like this..

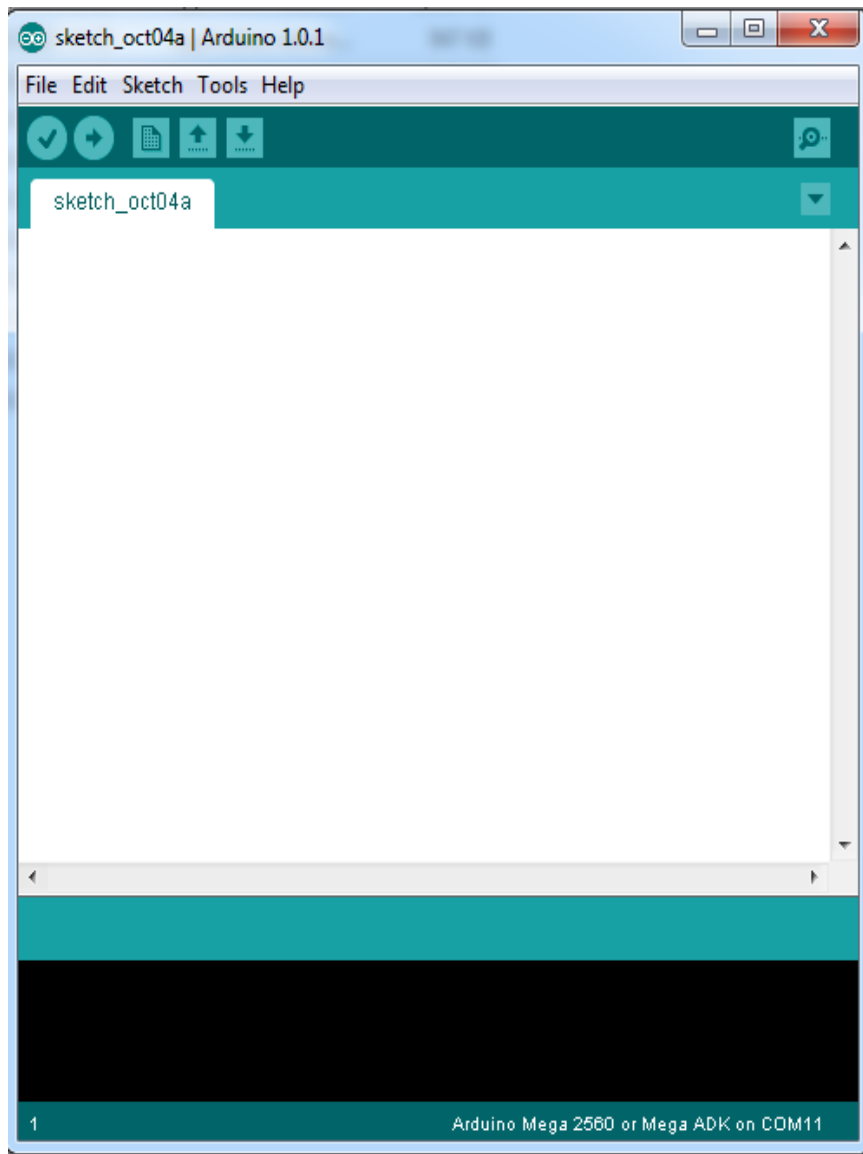

•

Under tools check that its is configured for the correct board, for the Crius is should be Arduino Mega 2560 or Mega ADk as shown below:



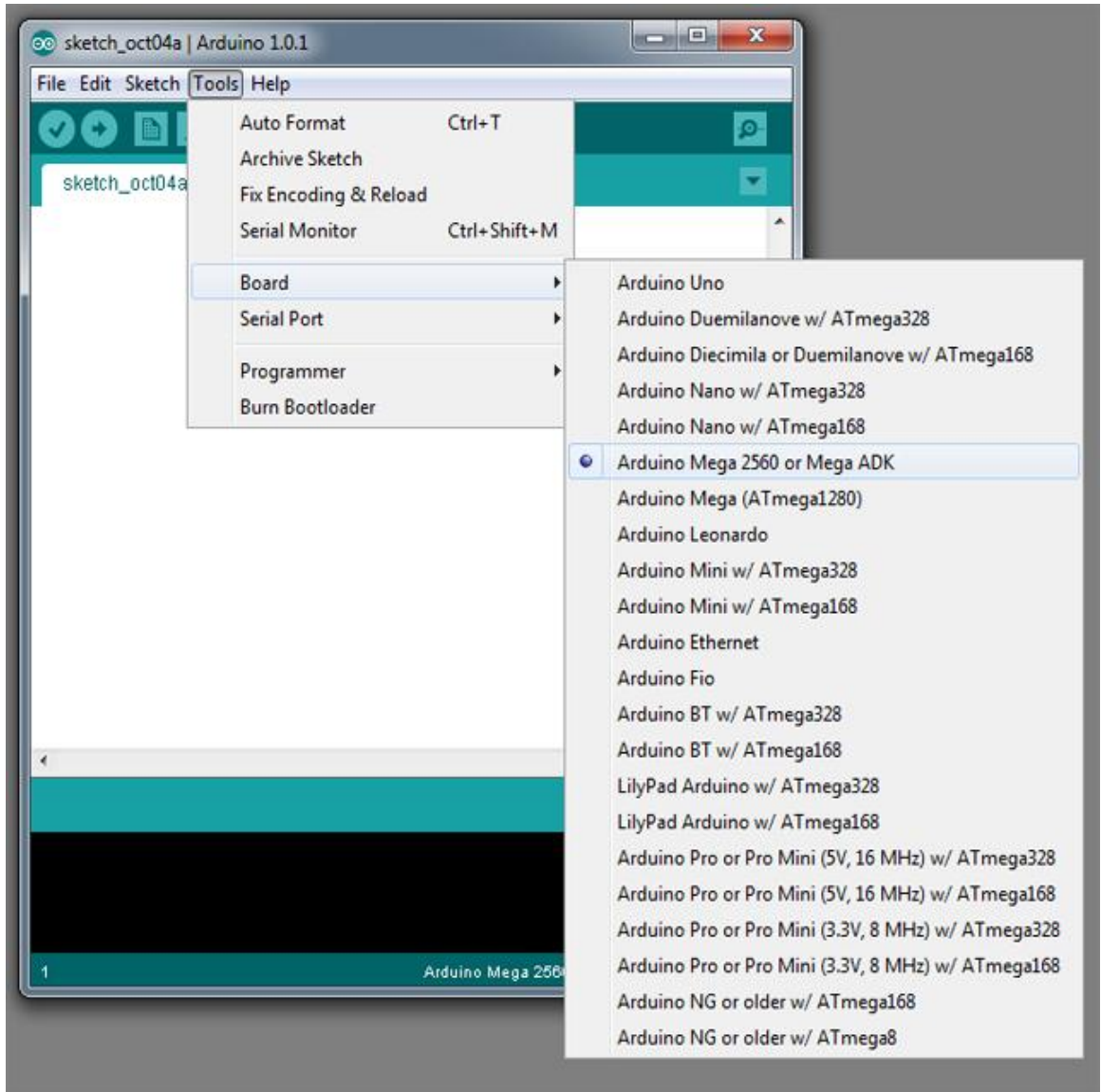

Now select the serial port the Crius AIO , this is normally auto detected. This is done in >Tools>Serial Port in the menu.

Ok we now have Arduino setup so the next step is to configure MegaPirate

Use File > Open in Arduino and navigate to the Megapirate folder your created, open the sub folder called ArduCopter. Inside this folder there is a file called ArduCopter.pde. open this file.

You should now have the screen shown below.....

## Crius AIO Pro V1.0 & V1.1 – MegaGuide for MegaPirateNG V1.1

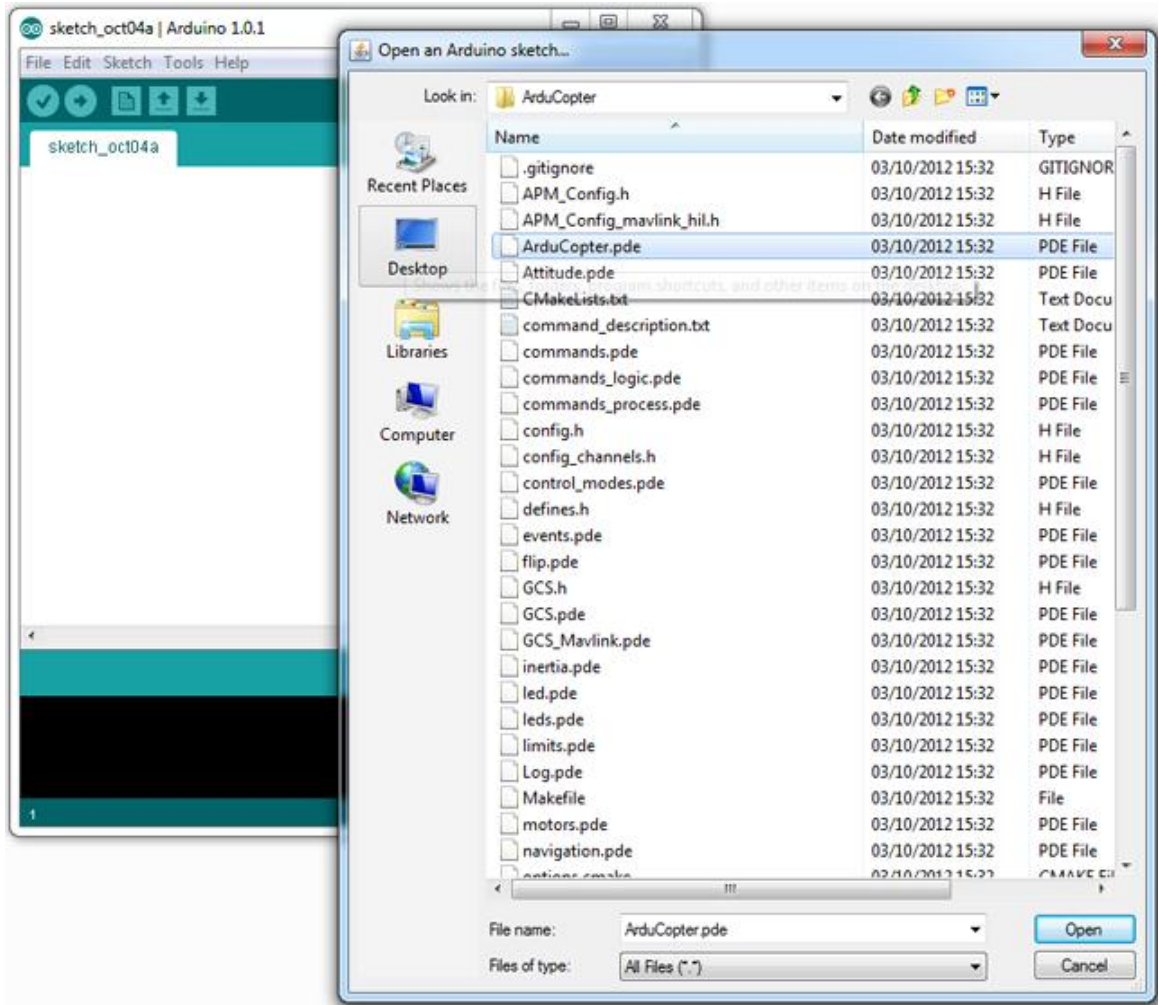

Open the File and the screen will pop up as shown below..

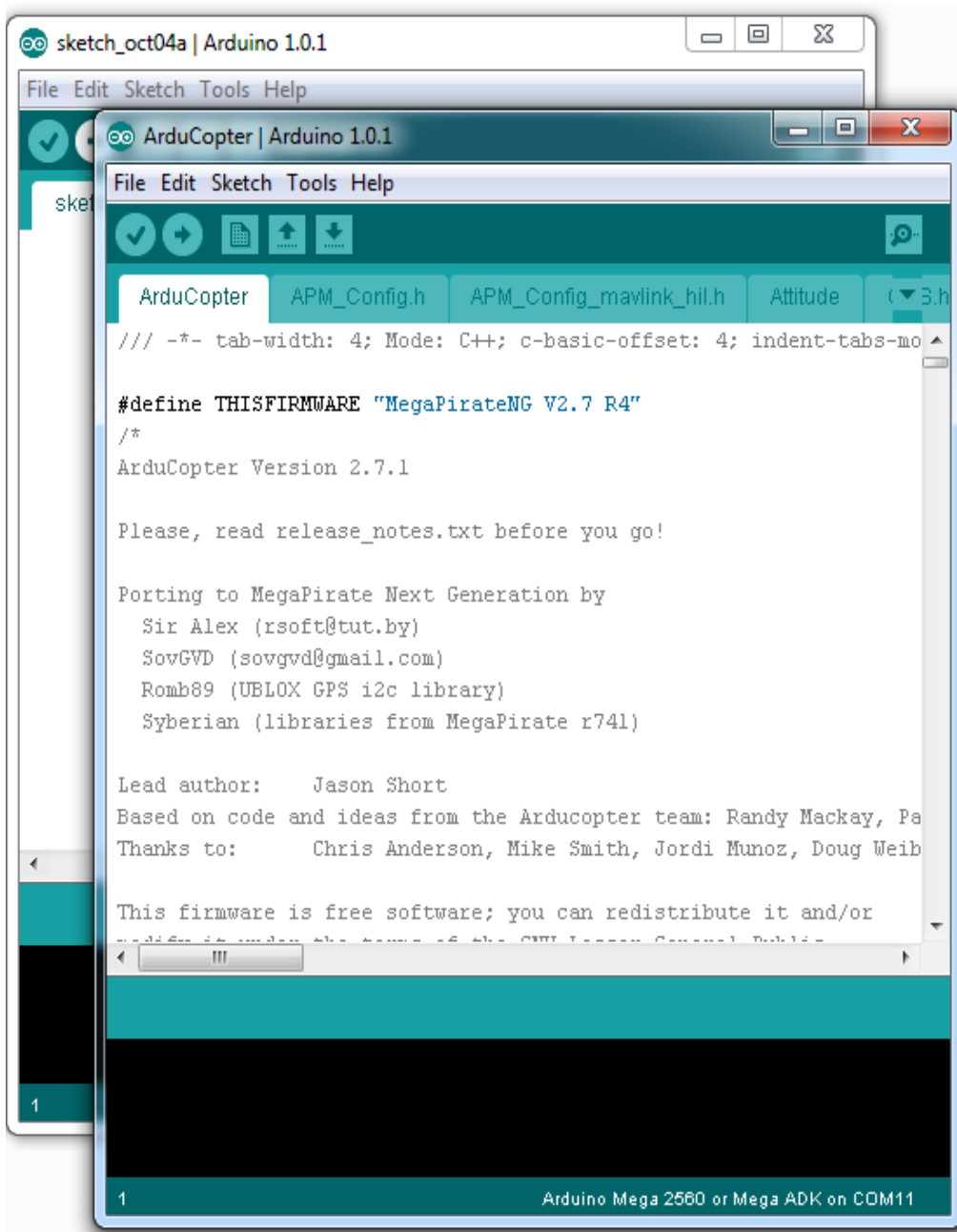

Close the window behind as you no longer need it, so you just have the window with the code shown.

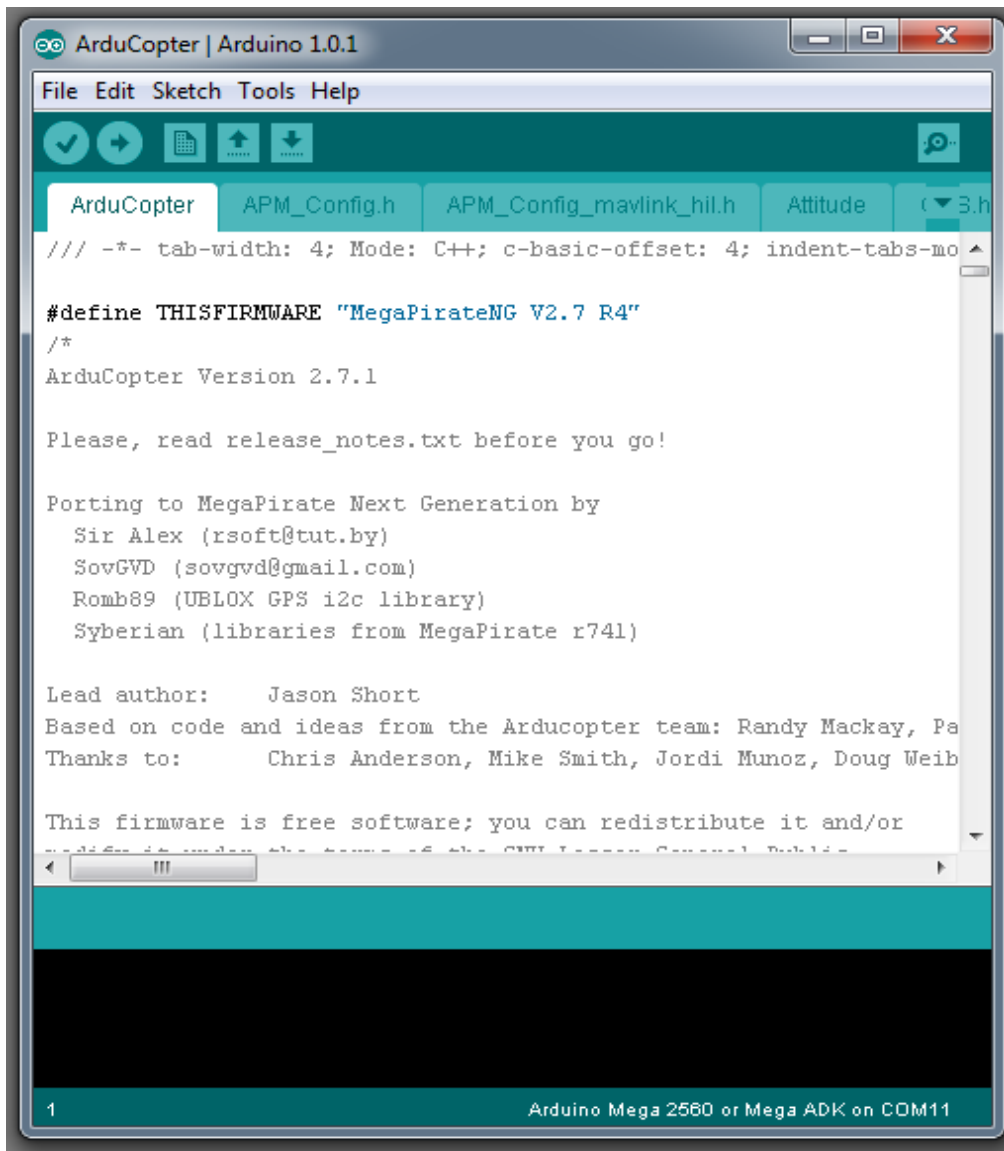

You will notice that there are tab's along the top the only one that we have to make changes to is the **APM\_Config.h** and as you can see by the picture above that this is the second tab along just click on this to edit it.

These are the parts of the code that we will need to change (sensor board).

First one is the Board Type, it should be changed to this:

```
#define PIRATES_SENSOR_BOARD PIRATES_CRIUS_AIO_PRO_V1
```

Second is the Baro, its should be changed to this:

```
#define CONFIG_BARO AP_BARO_MS5611_I2C
```

Third is the GPS, this will depend on what GPS you have:

For the Extend Board GPS it should be this: (IF USING UBLOX OR EXTEND BOARD)

```
#define GPS_PROTOCOL GPS_PROTOCOL_UBLOX
```

For all other GPS's try this:

```
#define GPS_PROTOCOL GPS_PROTOCOL_AUTO
```

Next you should set your Frame Type:

```
#define FRAME_CONFIG QUAD_FRAME (set to your own frame type from the list below)
```

```
QUAD_FRAME  
TRI_FRAME  
HEXA_FRAME  
Y6_FRAME  
OCTA_FRAME  
OCTA_QUAD_FRAME  
HELI_FRAME
```

Finally you should set your Frame Orientation:

```
#define FRAME_ORIENTATION X_FRAME (set to your own frame type from the list below)
```

```
PLUS_FRAME  
X_FRAME  
V_FRAME
```

(You may need to change other parts depending on what other hardware or options you have. The relevant sections are shown in the rest of this guide.

That's it nearly done, final set is to compile and upload to the Crius AIO board.

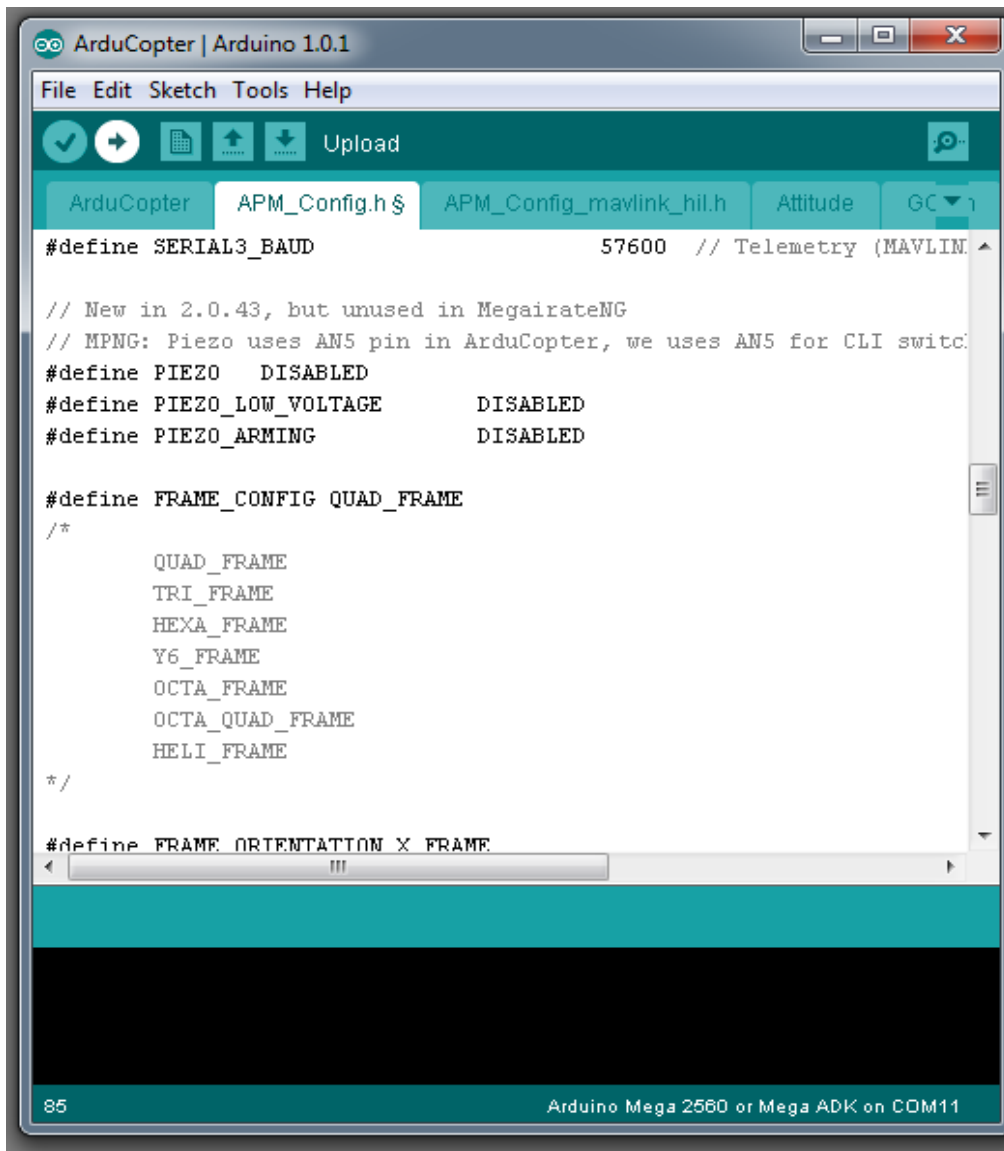

You should not get any errors, if you do go back to the beginning and start again. It is known to get errors if you have not copied the libraries folder from MegaPirate into the Arduino folder..... so if in doubt redo it.

Once you have successfully compiled and uploaded MegaPirateNG to your Crius Board you can now move onto installing APM Planner, checking the board and setting up your radio and calibration etc.

## Status LED's

A, B, C

LEDs:	Behavior:
A B	Fast flashing while calibrating gyros, booting etc
B	Flashing = Calibrating. Off = Ready
C	C Flashing while waiting for GPS lock; Solid with GPS lock
A C	Flashing A and Solid C = ready with GPS lock - Disarmed
A C	Solid A and C = Ready to fly with GPS lock - Armed

**NB:** LED's also change on flight mode change

## APM Planner

APM Planner was written for APM and as such not all features work on the Crius AIO with MegaPirateNG. For example you cannot upload firmware using this tool. A guide for setting up your Quad using APM Planner can be found in this document under “Getting Started”

APM Planner can be downloaded from here <http://code.google.com/p/ardupilot-mega/downloads/list>

APM Planner is used for calibrating your Crius AIO and checking and calibrating your radio.

The Planner can also be used for following:

- Calibrating radio
- Calibrating Crius horizontal and magnetic settings
- Setting up Attopilot Voltage and Current monitor
- Setting up Ultrasonic sensor
- Tuning PIDs (more on this later in the document)
- Setting flight modes

And much much more..... most of the settings are explanatory, but the Planner is quite powerful and can be used for full ground station work or setting up autonomous flight.

We suggest your refer to the Ardupilot Mega Wiki Guide here <http://code.google.com/p/ardupilot-mega/wiki/Mission>



## Power considerations

- Input power selection
- One of the following ways:
  1. Connect 5V power cable from ESC or UBEC to the ESC/Servo port, the J1 jumper must be closed.
  2. Connect 5V UBEC power cable to the extend power port, the J1 jumper must be removed.
- **Note: When using Extend Board, AIO PRO must be powered from the extend power port.**

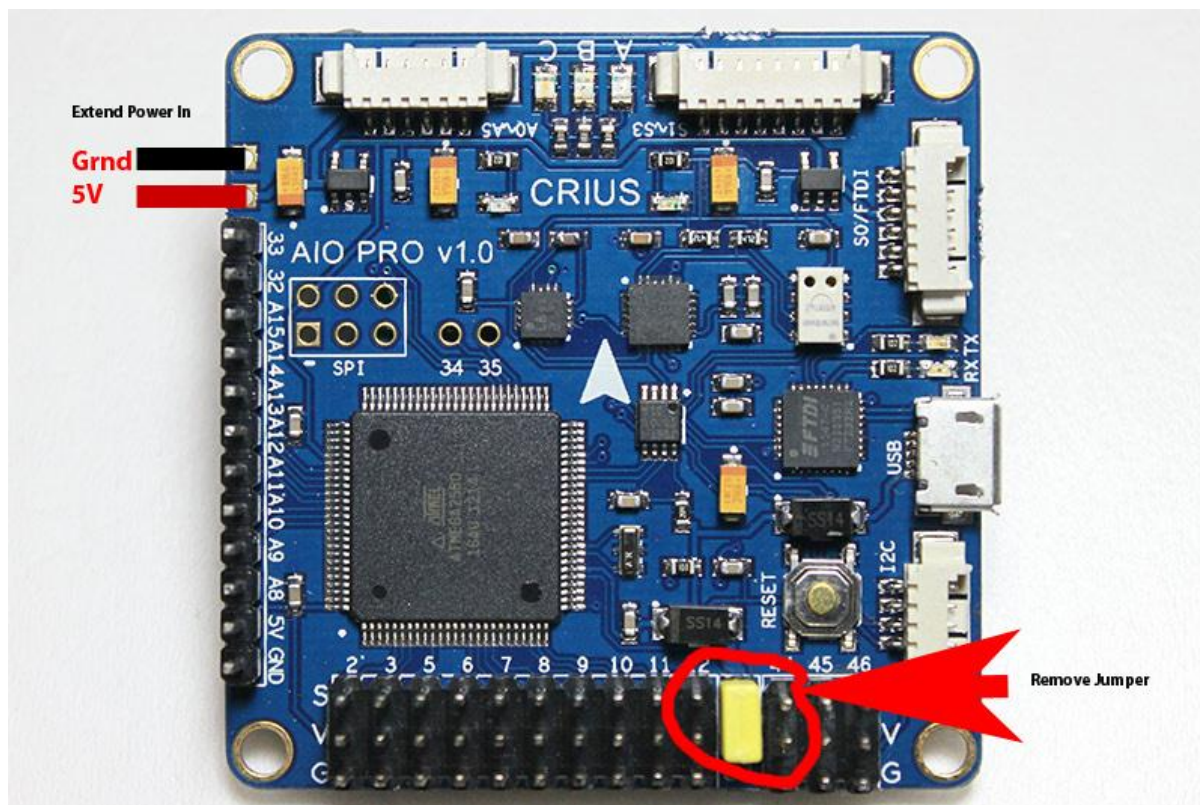

## Extend Board + GPS

### Features:

- Included U-blox LEA-6H GPS Module and Xbee socket.
- Working with AIO PRO FC, and provides full UAV functionality.
- 2 separated 3.3V LDO voltage regulator
- 25X25mm active GPS antenna with 200mm cable and IPEX plug

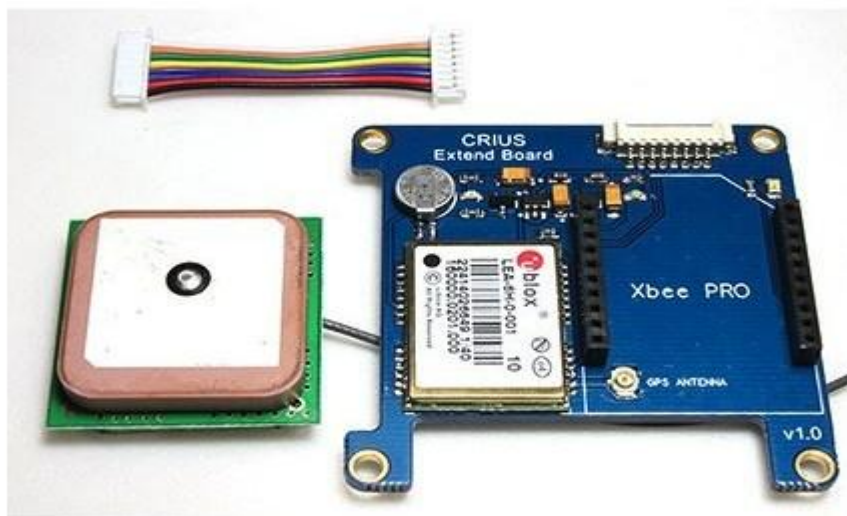

**IMPORTANT: When Extend Board connected to the AIO PRO FC, it must be powered by Extend Power Port (on the AIO PRO FC).**

## Crius AIO Pro V1.0 & V1.1 – MegaGuide for MegaPirateNG V1.1

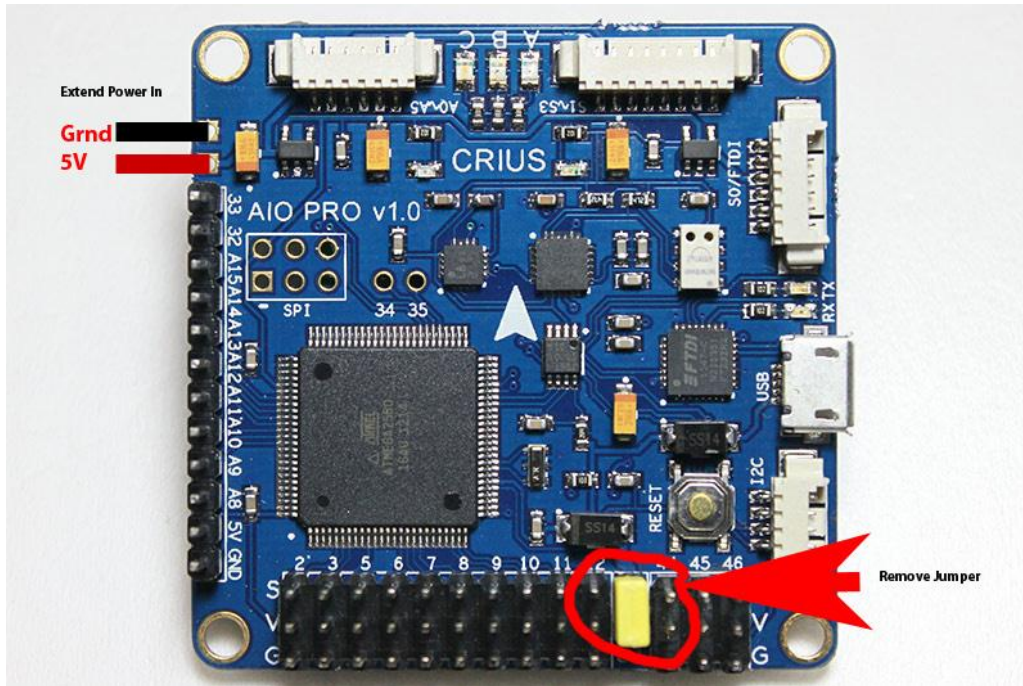

### General:

- Dimension: 50mmX50mm
- Height: mm
- Weight:±0.1g
- Fixing hole spacing: 45mm
- Hole diameter: 3mm

### Package content

- Extend Board x1
- GPS antenna x1
- Molex 1.25mm 8Pin to 8Pin cable 35mm x1

## GPS Connections

Most of the questions that arise for the Crius AIO are around how to connect and configure a GPS. The Crius will work with most GPS unit although attention should be paid to input levels.

3<sup>rd</sup> Party GPS Connections must be made to the S1-S3 Port and to TX2 and RX2, this is configured by **default to 38400 baud**. (To Change this edit [APM\\_Config.h](#) , see installing MegaPirateNG).

**Note: IF YOUR GPS IS NOT CONFIGURED FOR 38400 THEN EITHER CHANGE THE CODE BELOW OR RECONFIGURE ITS FIRMWARE.**

The CN-06 V1 is set at default to 9600 and although can be changed it will revert back to this when the battery goes flat, so therefore we recommend if using the CN-06 V1 that you set the baud rate to 9600 in the code below.

Remember: TX connects to RX and RX connects to TX

### TESTED GPS Units :

- **Crius Extend Board (LEA-6)**
- **CN06 V1**
- **CN-06 V2**
- **LEA-6**
- **3DR LEA-6**

(The LEA-6 from 3DR uses custom firmware and is currently the best available GPS for the Crius AIO)

The Crius AIO board which connects to the S0-S3 Port is configured on S2. The Extend board also has an Xbee socket which is connected to S3.

**Please Note :** No power is supplied to the S1-S3 port unless the power is supplied to the Extend Port in Port on the FC. (See Power Considerations Section).

The GPS needs to be configured in [APM\\_Config.h](#), in Arduino , the following line in red will need to be edited depending on what GPS you have installed. If in doubt use the AUTO Setting. The Extend board should set to UBLOX.

```
#define GPS_PROTOCOL GPS_PROTOCOL_UBLOX
```

```
/*
```

```
GPS_PROTOCOL_NONE    without GPS
```

```
GPS_PROTOCOL_NMEA
```

```
GPS_PROTOCOL_SIRF
```

```
GPS_PROTOCOL_UBLOX  <<< Select this for UBLOX LEA-6 (CRIUS GPS boards and others)
```

## Crius AIO Pro V1.0 & V1.1 – MegaGuide for MegaPirateNG V1.1

```
GPS_PROTOCOL_MTK16

GPS_PROTOCOL_BLACKVORTEX

GPS_PROTOCOL_AUTO    auto select GPS

*/

#define SERIAL0_BAUD          115200 // Console port

#define SERIAL2_BAUD          38400  // GPS port

#define SERIAL3_BAUD          57600  // Telemetry (MAVLINK) port
```

**Note: default ports and baud rates shown above.**

## Sonar



Connect HC-SR04 Sonar to the following Pins of the Crius AIO Pro:

HC-SR04 Pin GND <-> AIO PRO Pin GND  
HC-SR04 Pin Trig <-> AIO PRO Pin 9 TRIGGER  
HC-SR04 Pin Echo <-> AIO PRO Pin 10 ECHO  
HC-SR04 Pin Vcc <-> AIO PRO Pin 5V

## CPMM – PPM SUM

PPM Sum / CPPM is supported in MegaPirate NG and minimises the number of cables between your RX and the Crius AIO Board.

To enable PPM SUM you must edit the [APM\\_Config.h](#) and un-comment the following line in red to look like this:

```
*/  
  
// RC configuration  
  
// Uncomment if you uses PPM Sum signal from receiver  
  
#define SERIAL_PPM_ENABLED  
  
#define TX_CHANNEL_SETTX_mwi  
  
/*  
  
    TX_set1           //Graupner/Spektrum  
                      PITCH,YAW,THROTTLE,ROLL,AUX1,AUX2,CAMPITCH,CAMROLL  
  
    TX_standard       //standard PPM layout Robbe/Hitec/Sanwa  
                      ROLL,PITCH,THROTTLE,YAW,MODE,AUX2,CAMPITCH,CAMROLL  
  
    TX_set2           //some Hitec/Sanwa/others  
                      PITCH,ROLL,THROTTLE,YAW,AUX1,AUX2,CAMPITCH,CAMROLL  
  
    TX_mwi            //MultiWii layout  
                      ROLL,THROTTLE,PITCH,YAW,AUX1,AUX2,CAMPITCH,CAMROLL  
  
*/
```

You will then have to re-compile and upload MegaPirateNG to your board. Once you have done this check your channel mappings in APM Planner. If incorrect that if you can change mapping in your TX do so. If not then you will need to re-edit [APM\\_Config.h](#) and choose one of the other channel mappings by changing the text in green.

## Bluetooth

Bluetooth connections can be used to connect APM Planner to your Crius AIO Board. There are many modules available, some plug and play and others you will need to make a suitable cable for.

Connections are as follows using the supplied cable for the FTDI / SO Port as part of the Crius Package:

- RX – connects to Green
- TX – connects to Yellow
- Ground – Connects to Black
- + 5V – Connects to Red

The Bluetooth module connects to the FTDI / SO port whose baud rate is set at 115, 200 baud as default. The FTDI / SO port is shared with the USB port and both CANNOT be used at the same time.

**Please Note:** Copter GCS the Android App will not work over a direct Bluetooth connection with the Crius AIO . This is due to the way Mavlink is supported. To use this app you have to build a 3DR – Bluetooth Bridge. For more info on how to build a bridge see this link <http://code.google.com/p/copter-gcs/wiki/CopterLink>

## 3DR Radio's

3DR Radios will work for Ground Station Support and connection to APM Planner. There are currently two frequencies available 900Mhz and 433Mhz and you should choose the one that meets your countries regulations. 433 Mhz is recommend for UK and Europe.



The 3DR Radios can connect to the FTDI /S0 port or to S3 on the S1-S3 port. I would recommend using the Rx3 and Tx3 on the S1-S3 Port, as this will leave the FTDI port free for other uses such as Bluetooth. Using the S3 port will also not require any baud rate changes in APM\_Config.h.

The 3DR radios consist of a Remote and Local unit, the Local Unit is the USB one and the Remote is the smaller module.

Before you can use the modules they will need configured, to do so you will need to plug the USB one into your PC and the remote one will need powered by 5V + and Ground connection from the Crius.

**Remember and connect the antennas first as not doing so will damage the modules.**

Plugging the USB local module into your PC should auto install the drivers and a comm port will be configured automatically. If ensure check your ports in Devices. (Control Panel > System > Devices). If you need drivers they can be found here <http://www.ftdichip.com/Drivers/D2XX.htm>

There are two ways to configure the modules, either using APM Planner or the 3DR tool available. The 3DR tool can be found here <http://vps.oborne.me/3drradioconfig.zip>



**Crius AIO Pro V1.0 & V1.1 – MegaGuide for MegaPirateNG V1.1**

The First step is to configure the baud rate of both devices, if using S3 on the Crius as the input, then the 3DR's should be set at 57600 baud, if using the FTDI/ S0 port then the 3DR's should be setup for 115,200 baud. Most 3DR's are set up as default at 115,200 so to connect first time try this first. Once you have changed and saved the baud rate on the local and remote you will need to reconnect at the new baud rate.

**Caution: Make sure you change the settings for both remote and local at the same time. If the two are not the same you will not be able to connect to the remote. If you do change the settings and get them out of sync, all is not lost but you will need an FTDi adapter to change the settings on the smaller module.**

Set TX power to 20 (which is equal to 100mw)

The picture below shows the settings for a 433Mhz 3DR radio set in APM Planner connected to S3.



You should ensure that your radio's, frequency and settings etc are setup legally for the country of operation. For more info see below:

Region	Radio Model	Settings	Standard
USA	3DR 900	MIN_FREQ=902000 MAX_FREQ=928000 NUM_CHANNELS=50	FCC 15.247
Canada	3DR 900	MIN_FREQ=902000 MAX_FREQ=928000 NUM_CHANNELS=50	RSS-210 Annex 8.1
Australia	3DR 900	MIN_FREQ=915000 MAX_FREQ=928000 NUM_CHANNELS>=20	LIPD-2000 item 52
Australia	3DR 433	MIN_FREQ=433050 MAX_FREQ=434790 TXPOWER<=14	LIPD-2000 item 17
Europe (most)	3DR 433	MIN_FREQ=434040 MAX_FREQ=434790 TXPOWER<=8	ETSI EN300 220 7.2.3

## Crius AIO Pro V1.0 & V1.1 – MegaGuide for MegaPirateNG V1.1

countries)		NUM_CHANNELS>=30	
Europe (most countries)	3DR 433	MIN_FREQ=433050 MAX_FREQ=434790 TXPOWER<=8 DUTY_CYCLE=10	ETSI EN300 220 7.2.3
United Kingdom	3DR 433	MIN_FREQ=433050 MAX_FREQ=434790 TXPOWER<=8 DUTY_CYCLE=10	<a href="#">IR2030/1/10</a>
New Zealand	3DR 900	MIN_FREQ=921000 MAX_FREQ=928000	Notice 2007, Schedule 1
New Zealand	3DR 433	MIN_FREQ=433050 MAX_FREQ=434790	Notice 2007, Schedule 1
Brazil	3DR 433	MIN_FREQ=433000 MAX_FREQ=435000 TXPOWER<=8	<a href="#">Resolução ANATEL nº506/2008</a>
Brazil	3DR 900	MIN_FREQ=902000 MAX_FREQ=907500 NUM_CHANNELS>=11	Resolução ANATEL nº506/2008
Brazil	3DR 900	MIN_FREQ=915000 MAX_FREQ=928000 NUM_CHANNELS>=26	

### 3DR Status LEDs¶

The 3DR Radios have 2 status LEDs, one red and one green. The meaning of the different LED states is as follows:

- green LED blinking - searching for another radio
- green LED solid - link is established with another radio
- red LED flashing - transmitting data
- red LED solid - in firmware update mode

If you have the Extended Board with GPS then there are some special considerations to take into account. When the extended board with GPS is connected the cable connecting the two boards carries S1, S2 and S3. The S3 port is presented on the Xbee pins on the extend board. You therefore have two options to use the S3 port. 1. Cut and modify the cable that links the two boards, or 2. Use the Xbee pins. The Xbee pins are standard 2mm headers, so either modify some header pins or buy an Xbee breakout board as shown below. (Pin 2 Tx, Pin 3 Rx, Pin 10 Ground.). No 5v pin is available so power for the 3DR's will need to be taken from a UBEC or the Extend Board Power connection pins on the Crius AIO (See Power Considerations Options)

Xbee Pin Outs

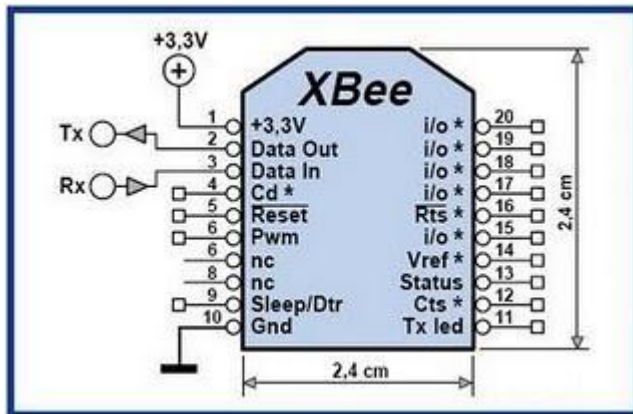

Example Xbee breakout board, this will plug into Xbee pins on Extend Board.

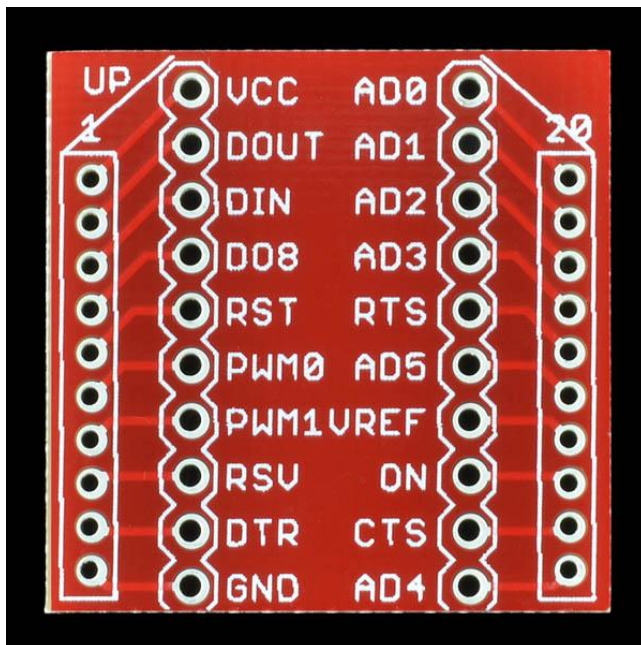

## MinimOSD

MinimOS connects to the S3 on the S1-S3 Port, **only the RX** from the OSD is connected to the TX of the S3 Port on the Crius AIO.

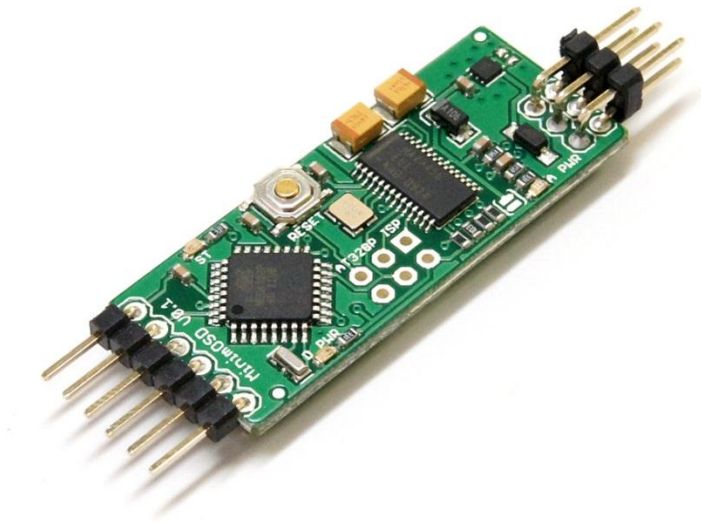

RSSI is normally handled by the APM and passed over Mavlink to the MinimOSD, but the Crius cannot process RSSI. Therefore an alternative way is to modify the MinimOSD to provide an input for the OSD and use an alternative software on the MinimOSD.

To date ONLY PWM RSSI as output from FrSKY Telemetry Receivers has been found to work.



To work with MinimOSD and a PWM RSSI input, an alternative version of the MinimOSD is available here <http://code.google.com/p/minimosd-extra/>. You will need to configure and install as detailed in the link. (If you do not require RSSI then the standard OS Build for the MinimOSD will be fine). To configure the OSD you will need an FTDI adapter to load and configure the firmware.

Note as standard MinimOSD's baud rate is 57600 which is the default setting for S3 on the S1-S3 port.

For more info on MinimOSD see [here http://code.google.com/p/arducam-osd/wiki/minimosd](http://code.google.com/p/arducam-osd/wiki/minimosd)

## JD-IO Board – FrSky Telemetry

The JD-IO takes the Mavlink data and converts it into FrSky telemetry format that you can then input into the FrSky telemetry series RX's on the telemetry serial port.

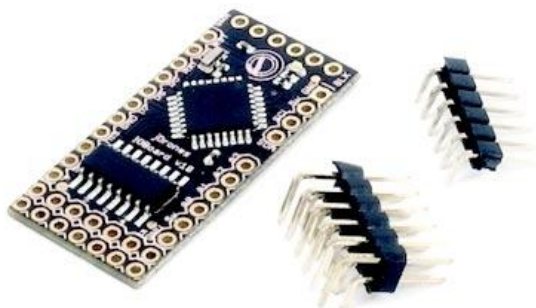



The FrSky telemetry receiver then sends the data via the radio link to your FrSky 2.4Ghz telemetry Tx's such as the DHT-U module, LCD display connected to a DHT or telemetry modified receiver with DHT and ER9X.



The JD-IO is still being developed, but at the moment current messages that are already working over FrSky telemetry are:

- Temperature
- Accel X, Y, Z
- Running time
- Altitude
- Groundspeed
- Lat / Lon

For more info on the JD-IO Board see this link: <http://www.buildyourowndrone.co.uk/JD-IO-board-v1-0-Driver-board-p/acq-ioboard.htm>

**Please note:** The MegaPirateNG team have indicated that this feature may be available natively on the Crius AIO Pro in future versions of MegaPirateNG without the need for the JD-IO board, this will use S1, TX1/RX1.

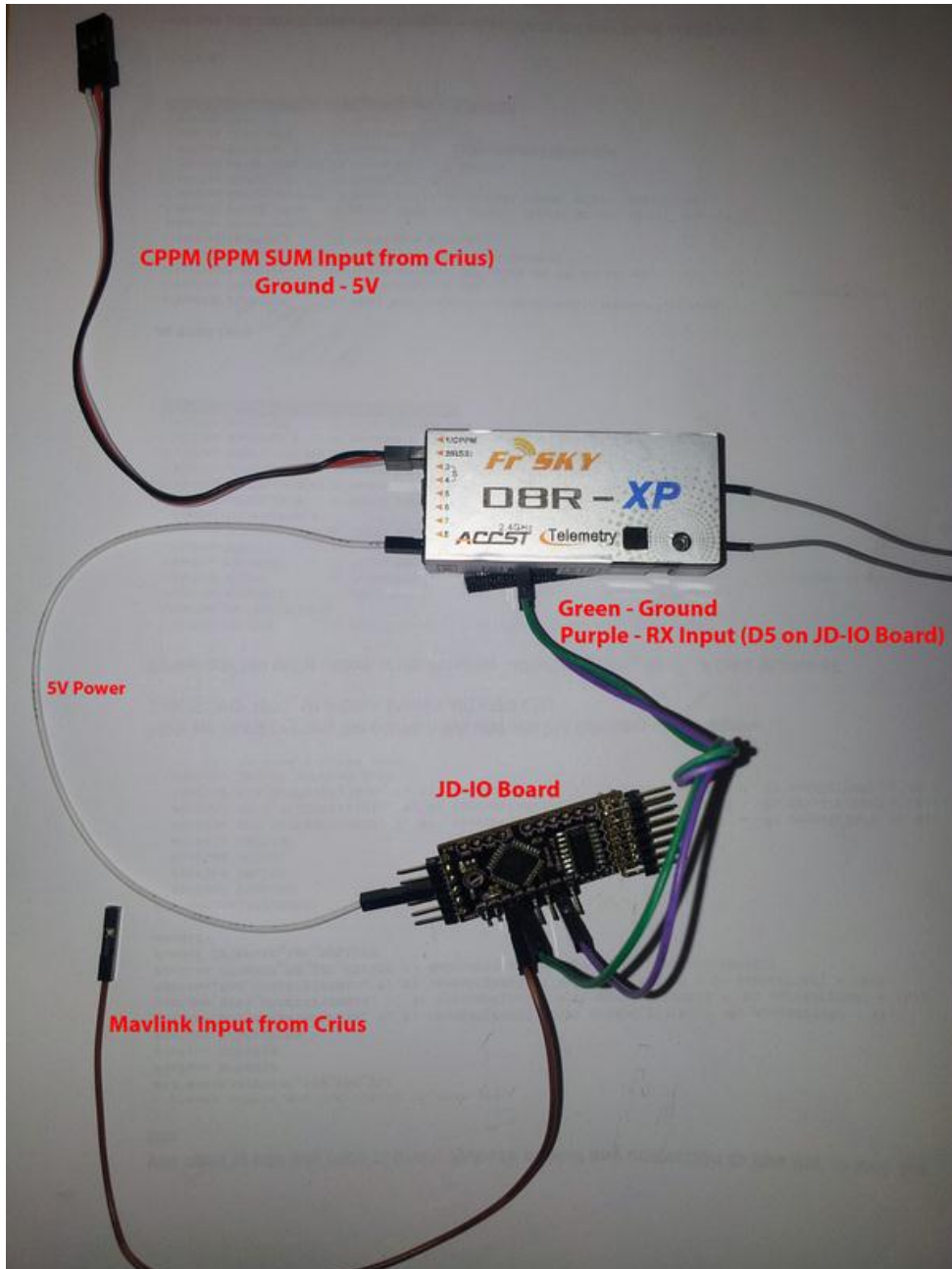

Mavlink input is normally found from TX3 on S3 at 57600 baud.

## Buzzer

*(This has not been tested but forum members had indicated it works)*

It is possible to connect a Piezo buzzer to indicate arming, disarming and low voltage on the Crius AIO Pro. This can be connected between Pin 32 on the Crius board and using a 1k resistor to ground.

An alternative and safer connection can be made using a NPN transistor to protect the Crius output on Pin 32 as shown below:

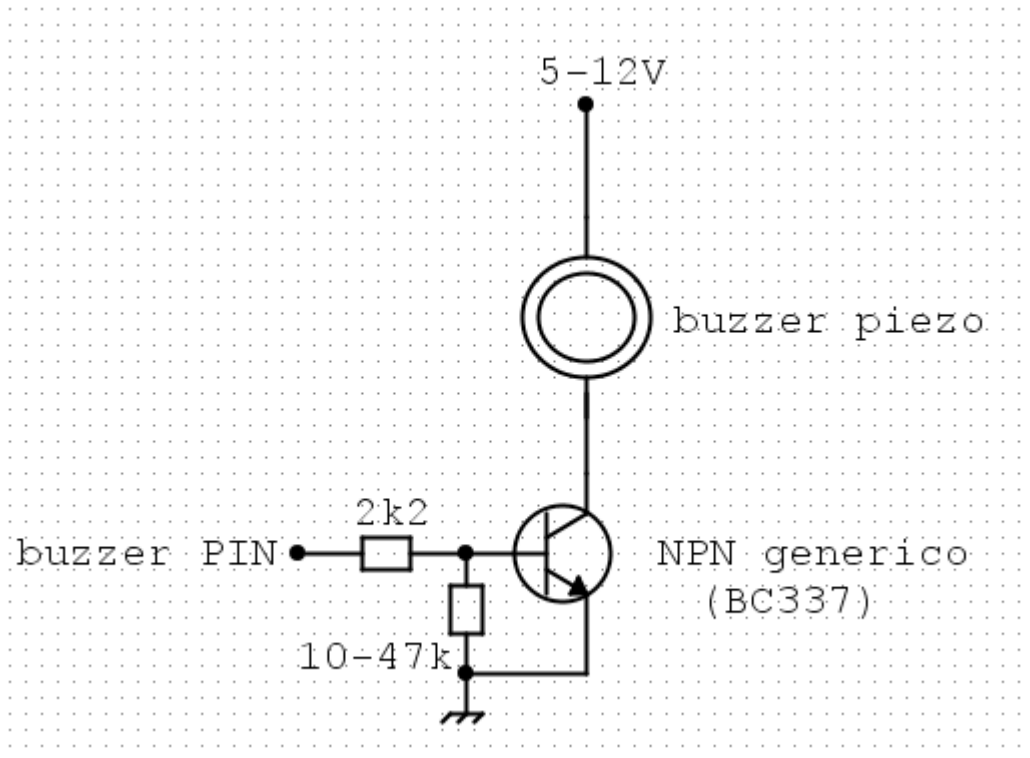

**APM\_Config.h** needs modified as below:

```
// New in 2.0.43, but unused in MegairateNG  
  
// MPNG: Piezo uses AN5 pin in ArduCopter, we uses AN5 for CLI switch  
  
#define PIEZO      ENABLED  
  
#define PIEZO_LOW_VOLTAGE      DISABLED  
  
#define PIEZO_ARMING      ENABLED
```

**Defines.h** needs modified as below:

```
#define AN5 32 // direct GPIO pin, default as analog input, next to SW2 switch
```

## AttoPilot



## Crius AIO Pro V1.0 & V1.1 – MegaGuide for MegaPirateNG V1.1

The Crius AIO is capable of measuring Voltage and Current by using the Mini Attopilot Modules. MegaPirateNG is already configured for this using Pins A0 and A1.

This data is also passed onto Mavlink and can be viewed in APM Planner and MinimOSD if configured.

- V-Pin of the Attopilot connected to the A0 Pin of the Crius board
- I-Pin of the Attopilot connected to the A1 Pin of the Crius board
- GND of Attopilot to Ground on Crius AIO board
- IN+ from battery
- Out + to ESC, BEC's etc
- Heavy Ground to Battery



## First Tests (Written for a Quad but similar principles apply to most Multi's)

See this great tutorial, it's written for APM but should tell you how to get started.

[http://arducopter.googlecode.com/files/APM2\\_Quad\\_Setup\\_3.pdf](http://arducopter.googlecode.com/files/APM2_Quad_Setup_3.pdf)

## Tuning PIDS

Another great guide and tutorial to PID tuning for APM

[http://arducopter.googlecode.com/files/APM2\\_Quad\\_Stabilize\\_1.pdf](http://arducopter.googlecode.com/files/APM2_Quad_Stabilize_1.pdf)

Appendix - Motor Connections

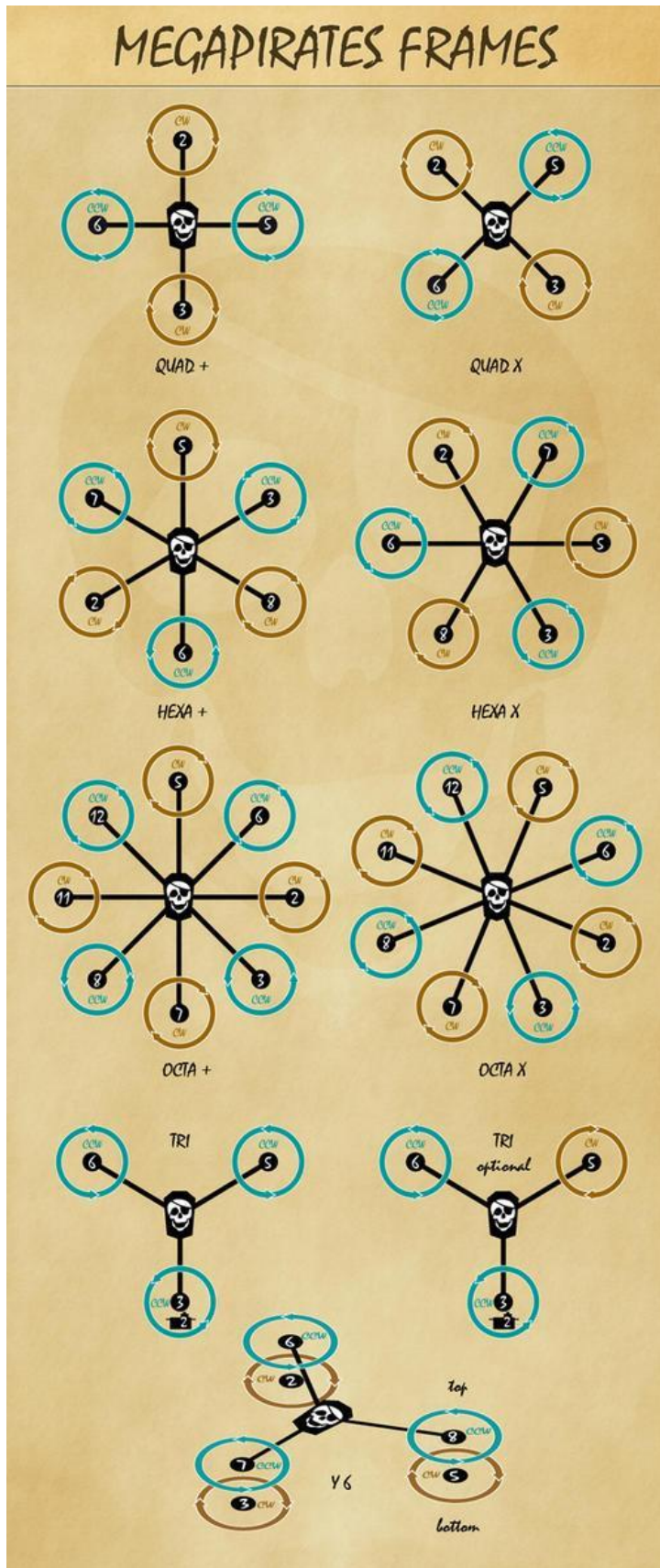

## Sources & Credits

MegaPirateNG <http://code.google.com/p/megapirateng/>

APM Planner <http://code.google.com/p/ardupilot-mega/wiki/Mission>

MinimOSD <http://code.google.com/p/arducam-osd/wiki/minimosd>

Multi Rotor UK Forum members <http://www.multi-rotor.co.uk>

And of course all of the people on RCGroups community...